



# GENERAL INSTALLATION INSTRUCTION

Shower Curtain Rod



## PREPARATION

Tools Required for Assembly: (Not included)

- Pencil
- Electrical drill with 5/16 in. drill bit
- Hammer
- Philips head screwdriver
- Tape measure
- Level
- Safety Glasses
- Hack saw

**CAUTION:** Drywall anchors are for drywalls only. Use tile anchors for tile surfaces. (Not included)

## INSTALLATION INSTRUCTIONS

1. Remove flange cap from base by twisting counter-clockwise. (Fig. 1)

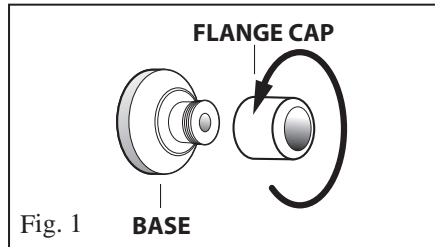

2. Use back plate as an outline to mark desired position on wall and location of mounting screw holes. (Fig. 2)

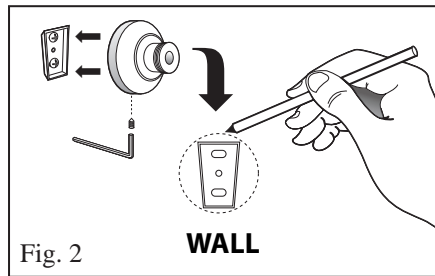

3. Drill 5/16 in. pilot holes into the wall where the molly bolts will be inserted using an electrical drill. Tap molly bolts into the pilot holes using a hammer. Use an electrical screwdriver to tighten the screws. This will collapse the molly bolts tightly to the wall. Unscrew the screws from the molly bolts. Molly bolts will remain in the wall. (Fig. 3)

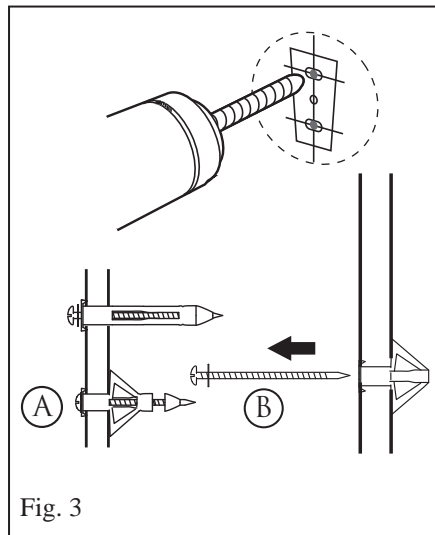

4. Fasten mounting bracket to wall with mounting screws. (Fig. 4)

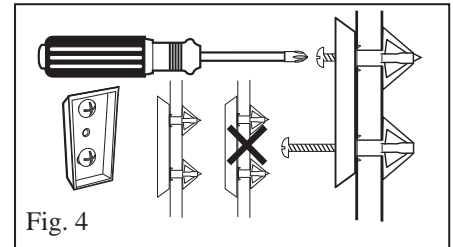

5. Place back plate over bracket and retighten set screw. (Fig. 5)

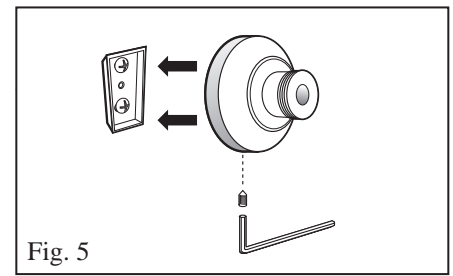

6. Using hack saw, cut shower rod to desired length (if necessary). Shower rod ends should fit flush between two back plates. (Fig. 6)

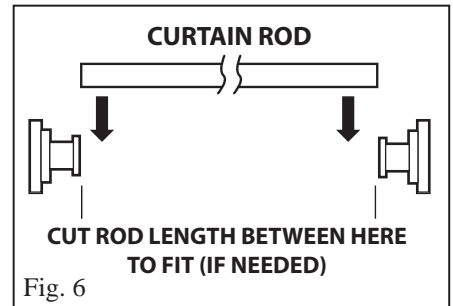

7. A) Slide flange caps onto ends of curtain rod, B) with flange caps on the end of rod, tighten flange caps onto each base by applying pressure and turning clockwise. (Fig. 7)

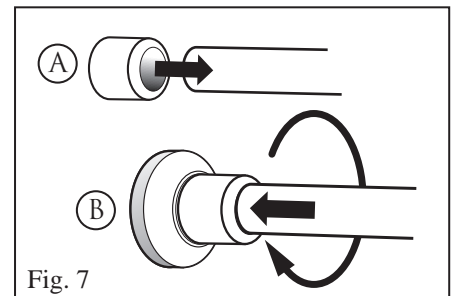

## CARE AND MAINTENANCE

To maintain the beautiful luster finish, please use soft damp cloths when cleaning and never use any cleaning solvents.